

ARK-2151V

In-Vehicle Full HD NVR w/4 PoE Ports 4th Gen. Intel® Core i5 4300U / Celeron 2980U SoC Fanless Box PC



Features

- Intel® Celeron 2980U 1.6GHz / Core i5-4300U 1.9 GHz SoC
- 4 PoE Ports to Support Mainstream IP Cameras
- Diversity Communication Abilities, ex. WWAN, WLAN
- Intelligent Vehicle Power Ignition
- 9 ~ 36 V_{DC}* Wide Power Input w/isolation
- 1 x Removable 2.5" drive bay
- Supports iManager, SUSIAccess and Embedded Software APIs



Specifications

| | | ARK-2151V-S6A1E | ARK-2151V-S9A1E |
|-------------------|--------------------------|--|--|
| Processor System | CPU | Intel Celeron 2980U Dual Core | Intel i5-4300U Dual Core |
| | Frequency | 1.6 GHz | 1.9 GHz |
| | L3 Cache | 2 MB | 3 MB |
| | BIOS | AMI EFI 128 Mbit | |
| Memory | Technology | DDR3L 1333 MHz | DDR3L 1600 MHz |
| | Max. Capacity | 8 GB | |
| | Socket | 1 x 204-pin SO-DIMM | |
| Graphics | Chipset | HD Graphics | GT2-4400 Graphics |
| | Graphic Engine | DirectX11.1, OpenGL 4.0, and OpenCL 1.2 Full AVC/VC1/MPEG2 HW Decode | |
| | VGA | Up to 1920 x 1200 with 60 Hz, 154 MHz pixel clock rate | |
| | HDMI | Lockable HDMI connector, up to 4K at 24 Hz | |
| Audio | Main System | Realtek ALC888S, High Definition Audio (HD), Line-in, Line out, Mic-in | |
| Ethernet | LAN #1 | 10/100/1000 Mbps Intel I218 GbE, support Wake on LAN | |
| | LAN #2 | 10/100/1000 Mbps Intel I210-IT, support Wake on LAN | |
| I/O Interface | Power over Ethernet, PoE | N/A | 4 x 10/100 Mbps - 4ports full-load, IEEE802.3af Class 2 (7Watt) - 2ports full-load, IEEE802.3af Class 3 (15.4Watt) |
| | Serial Ports | 2x isolated RS-232/422/485 with auto flow control (3KV isolation) 2x non-isolated RS-232/422/485 with auto flow control | 2x non-isolated RS-232/422/485 with auto flow control |
| | CANBus | Option, 2ch CANBus 2.0A/B (1xCOM will be replaced) | |
| | USB Interface | 2 x USB 2.0 & 2 x USB3.0 | |
| | GPIO | 6 x DI & 2 x DO w/3KV isolation Input Voltage: 0 to 30 V _{DC} , Output Current: Max. 500 mA per channel On-state Voltage: 24 V _{DC} nominal, open collector to 30 V _{DC} | |
| Other | Watchdog timer | 255-level timer interval, setup by software | |
| Expansion | Mini PCIe #1 | Full-size Mini PCIe w/SIM holder (PCIe, USB, SATA interface) | |
| | Mini PCIe #2 | Half-size Mini PCIe (PCIe interface) | |
| | Mini PCIe #3/4 | 2 x Full-size Mini PCIe w/SIM holders (USB interface) | |
| Storage | 2.5" Drive Bay | 1 x removable 2.5" drive bay (Standard 9.5mm height, 15mm height support by project) | |
| | mSATA | Leverage MiniPCIe #1 slot | |
| Software Support | Microsoft Windows | WES8, WES7, Windows 8, Windows 7 | |
| | Linux | Support by project | |
| Power Requirement | Power Type | ATX/AT | |
| | Power Input Voltage* | 9 ~ 36 V _{DC} w/isolation | |
| | Vehicle Power Ignition | Selectable boot-up & shut-down voltage, on/off delay time | |
| | Power Consumption | 26W (Typical), 46W (Max) | 26W (Typical), 76W (Max) |
| Mechanical | Isolation | 1.5 KV Isolated | |
| | Construction | Aluminum housing, Silver | |
| | Mounting | Din-Rail mounting, Desk/wall-mounting, VESA mounting | |
| Environment | Dimensions (W x H x D) | 264.5 x 75.1 x 133.0 mm (10.41" x 2.96" x 5.24") | |
| | Operating Temperature | With extended temperature peripherals:-20 ~ 60° C with 0.7m/s air flow With standard temperature peripherals:0 ~ 45° C with 0.7m/s air flow | |
| | Storage Temperature | -40 ~ 85° C (-40~185° F) | |
| | Relative Humidity | 95% @ 40° C (non-condensing) | |
| | Vibration/Shock | With mSATA/SSD: IEC 60721-3-5 Class 5M3 | |
| Regulation | EMC | CE/FCC Class A, CCC, BSMI | |
| | Safety | UL, CCC, BSMI, E-Mark (E13) (No RED certification) | |
| | In-Vehicle Power | ISO7637-2 Lev.4 | |

* Power Input Constraint at low voltage: 9-10.9V.

Dimensions

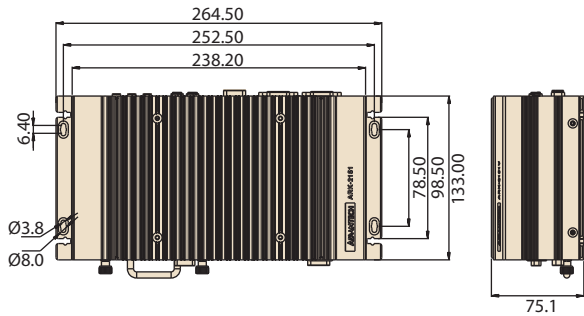

DIN Rail

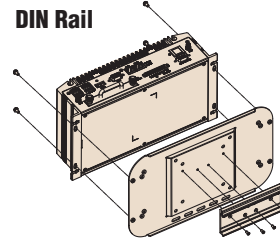

Unit: mm

VESA mount

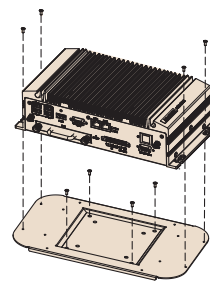

Wall mount

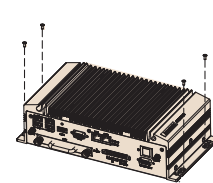

ARK-2151V-S6A1E External I/O Mechanical Layout/Drawing

Front Panel

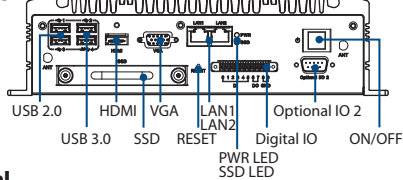

Rear Panel

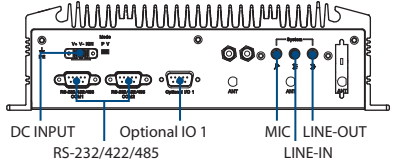

ARK-2151V-S9A1E External I/O Mechanical Layout/Drawing

Front Panel

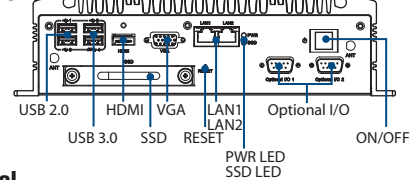

Rear Panel

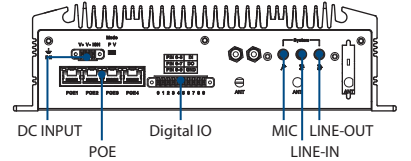

Ordering Information

| Part Number | Intel CPU | RAM | 2.5" Drive | mSATA | Display | GbE | PoE | USB | DIO | COM | MiniPCIe | SIM Holder | Power Input | Operating Temperature |
|-----------------|-----------------------------|-----------|------------|-------|---------------------|-----|-----|--------------------------|------------|--------|--------------------------------|------------|-------------|-----------------------|
| ARK-2151V-S6A1E | Intel Celeron 2980U 1.6 GHz | Up to 8GB | 1 | 1 | 1 x HDMI 1 x VGA | 2 | N/A | 2 x USB2.0 2 x USB3.0 | 6Di 2Do | 4 2 | 3 x Full Size 1 x Half Size | 3 | 9 ~ 36 Vdc | -20 ~ 60° C |
| ARK-2151V-S9A1E | Intel i5-4300U 1.9 GHz | | | | | | | | | | | | | |

Packing List

| Part Number | Description |
|-------------|--------------------------------------|
| - | 1 x ARK-2151 Unit |
| - | 1 x Driver/Utility CD/Manual |
| - | 1 x User Manual (Simplified Chinese) |
| 1652000049 | 3-pole phoenix power block 3.81mm |
| 1652003235 | 10-Pin DIO plug in block |

Optional Items

| Part Number | Description |
|-----------------|--------------------------------------|
| 96PSA-A120W19T2 | AC-to-DC Adapter |
| 1702002600 | Power Cable 3-pin 180cm, USA type |
| 1702002605-02 | Power Cable 3-pin 183cm, Europe type |
| 1700018704 | Power Cable 3-pin 183cm, UK type |
| AMK-V004E | VESA mounting kit |
| AMK-R004E | DIN-rail mounting kit |

Embedded OS

| Part Number | Description |
|-------------|---|
| 2070013560 | ARK-2151V-S6A1E WES7 E OS image |
| 2070013568 | ARK-2151V-S9A1E WES7 E OS image |
| 2070013599 | ARK-2151V-S6A1E WE8S OS image |
| 2070013600 | ARK-2151V-S9A1E WE8S OS image |
| 2070014978 | ARK-2151V WES7 P OS image (10MUI, 64bit) |
| 2070014995 | ARK-2151V Win10 IoT Enterprise OS image (US, 64bit) |

*Default BIOS is supported for 64-bit OS installation, BIOS 32-bit OS is supported by project

Online Download www.advantech.com/products

