

**ICS series**

**ICS-1000**

Narada's ICS series battery designed to provide highcycling and fast charge performance, idea for telecom service where power supply is unstable. With innovative structure design, high quality manufacturing and high quality material, ICS batteries are also capable of PSoC, hybrid, renewable energy storage application and other cycling/standby applications.



**Specifications**

<b>Battery Model</b>	<b>ICS-1000</b>	
Nominal voltage	2V	
Capacity	1000Ah (10HR ,100A, 1.80V, 25°C)	
Approx.Weight	65.5kg	
Internal Resistance	Approx 0.20mΩ	
Max Charge Current Allowed	250A	
Charge Voltage (25°C)	Cycle use	Float use
	2.35V/cell	2.25V/cell
Temperature Ranges	Operation(maximum): -40°C to 55°C (-40°F to 131°F)	
	Operation(recommended): 15°C to 25°C ( 59°F to 77°F)	
	Storage: -20°C to 40°C (-4°F to 104°F)	
Terminal	M8 Female	
Terminal Hardware	15 ± 1.0 N.m	
Container Material	ABS (V0 optional)	

**Dimensions (mm)**

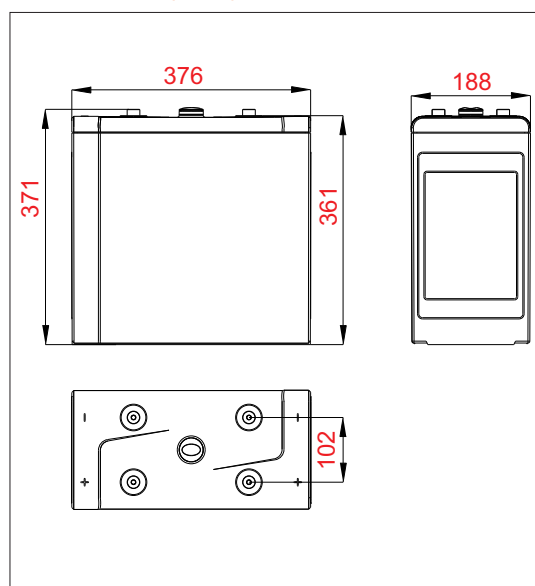

**Constant Current Discharge Data Units: Amperes (25°C, 77°F)**

End voltage per cell	15min	20min	30min	40min	50min	1h	2h	3h	5h	8h	10h
1.65V	1180	1080	870	750	660	565	340	260	175	126	108
1.70V	1100	1010	830	720	640	560	337	257	170	120	106
1.75V	1020	920	780	680	600	555	335	255	168	116	104
1.80V	890	820	730	640	565	552	333	252	166	112	102

**Constant Power Discharge Data Units: Watts per cell (25°C, 77°F)**

End voltage per cell	15min	20min	30min	40min	50min	1h	2h	3h	5h	8h	10h
1.65V	2200	1980	1690	1400	1270	1080	720	560	405	288	255
1.70V	2050	1890	1580	1360	1180	1040	705	545	380	265	240
1.75V	1950	1780	1480	1280	1100	990	690	535	360	245	230
1.80V	1780	1600	1370	1190	1020	960	665	510	330	221	205

**ICS series**

**ICS-1000**

**Discharge Voltage vs Time Curve ( 25°C )**

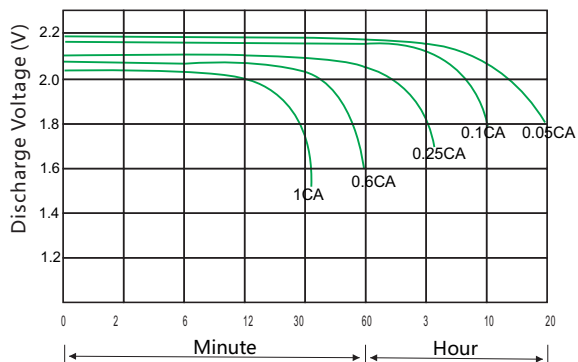

**Charge Curve (25°C)**

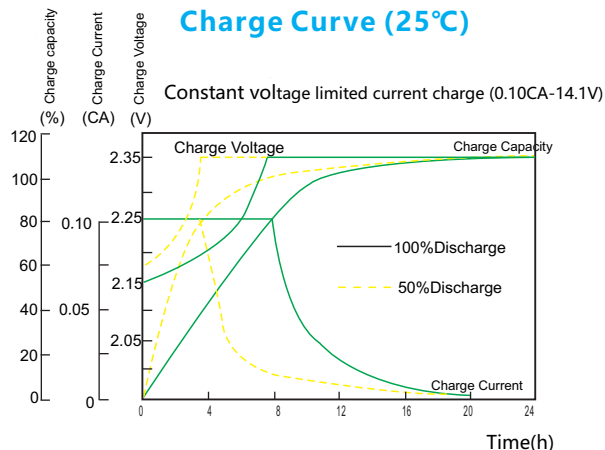

**Capacity vs temperature curve**

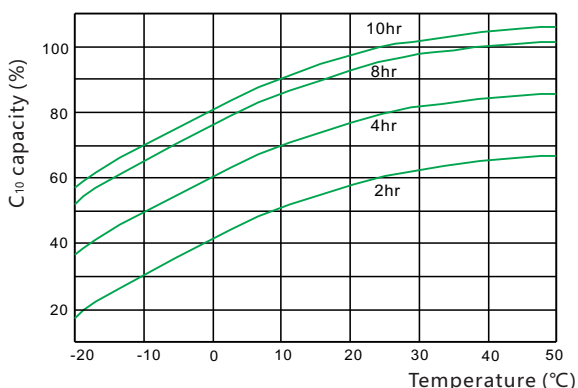

**Residual Capacity vs Storage Time**

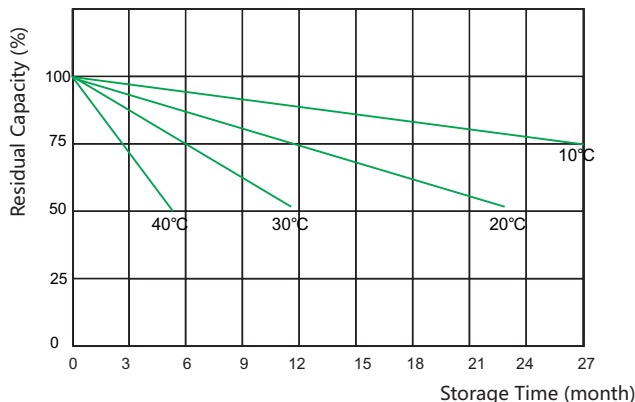

**Capacity vs OCV curve**

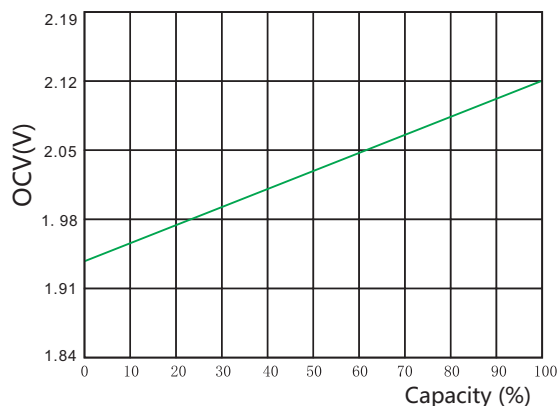

**Design life vs temperature**

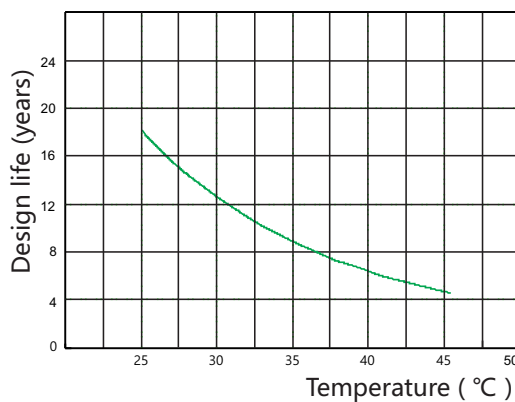

**NARADA POWER SOURCE CO.,LTD.**  
 Building A, No.822 Wen'er West Road, Hangzhou, China  
 Tel:+86-571-56975980 Fax:+86-571-56975955  
 E-mail: intl@narada.biz  
 Website:www.naradapower.com

**NARADA ASIA PACIFIC PTE.LTD.**  
 Block 9 Khaki Bukit Road 1 #02-10 Eunos Technolink,  
 Singapore 415938 Email: sales@narada-ap.com  
 Tel: +65-6848 1191 Fax: +65-6749 3498  
 Website: [www.narada-ap.com](http://www.narada-ap.com)

**NARADA EUROPE (UK) LIMITED**  
 Spectrum House, Dunstable Road, Redbourn,  
 St. Albans, Herts AL3 7PR  
 Tel: +44 (0)845 371 7095 Fax:+44 (0)845 612 2031  
 E-mail: sales@naradaeurope.com



Copyright Narada Power Source Co., Ltd.

[www.naradapower.com](http://www.naradapower.com)

**TEMPEL GROUP ARGENTINA**  
[www.tempelgroup.com](http://www.tempelgroup.com)  
 baires@tempelgroup.com  
 Tel.+54 11 4897-7184/7178

**TEMPEL GROUP en el mundo**  
 BUENO AIRES • MADRID • VALENCIA • BILBAO • SEVILLA •  
 LISBOA • PORTO • LIMA • SÃO PAULO • SANTIAGO DE CHILE • BOGOTÁ •  
 CIUDAD DE MÉXICO • CIUDAD DE PANAMÁ • MONTEVIDEO • QUITO

