

**ICS series**

**ICS-300**

Narada's ICS series battery designed to provide highcycling and fast charge performance, idea for telecom service where power supply is unstable. With innovative structure design, high quality manufacturing and high quality material, ICS batteries are also capable of PSoC, hybrid, renewable energy storage application and other cycling/standby applications.



**Specifications**

|                            |  |            |
|----------------------------|--|------------|
| <b>Battery Model</b>       | <b>ICS-300</b>                                       |            |
| Nominal voltage            | 2V   |            |
| Capacity                   | 300Ah (10HR ,30A, 1.80V, 25°C)                       |            |
| Approx.Weight              | 22kg   |            |
| Internal Resistance        | Approx 0.42mΩ  |            |
| Max Charge Current Allowed | 75A  |            |
| Charge Voltage (25°C)      | Cycle use  | Float use  |
|                            | 2.35V/cell   | 2.25V/cell |
| Temperature Ranges         | Operation(maximum): -40°C to 55°C (-40°F to 131°F)   |            |
|                            | Operation(recommended): 15°C to 25°C ( 59°F to 77°F) |            |
|                            | Storage: -20°C to 40°C (-4°F to 104°F)               |            |
| Terminal                   | M8 Female  |            |
| Terminal Hardware          | 15 ± 1.0 N.m   |            |
| Container Material         | ABS (V0 optional)                                    |            |

**Dimensions (mm)**

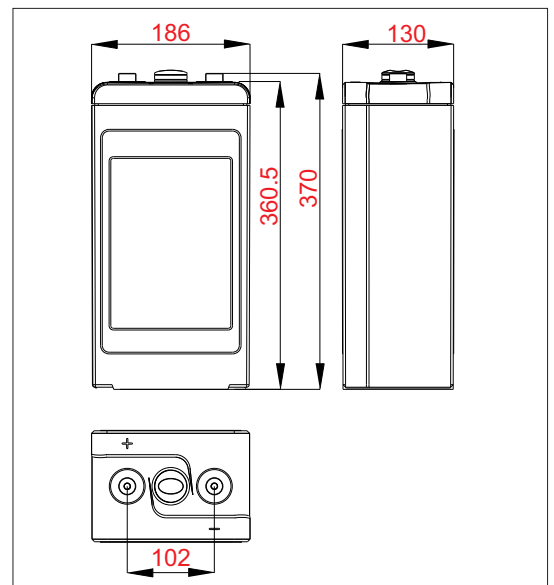

**Constant Current Discharge Data Units: Amperes (25°C, 77°F)**

| End voltage per cell | 15min | 20min | 30min | 40min | 50min | 1h  | 2h  | 3h   | 5h   | 8h   | 10h  |
|----------------------|-------|-------|-------|-------|-------|-----|-----|------|------|------|------|
| 1.65V                | 360   | 320   | 265   | 230   | 210   | 172 | 105 | 80.0 | 55.0 | 38.0 | 33.0 |
| 1.70V                | 330   | 305   | 245   | 220   | 200   | 170 | 103 | 78.0 | 52.0 | 36.0 | 32.0 |
| 1.75V                | 310   | 280   | 230   | 210   | 185   | 168 | 102 | 77.0 | 50.0 | 35.0 | 31.0 |
| 1.80V                | 270   | 255   | 220   | 195   | 165   | 166 | 100 | 76.0 | 48.0 | 34.0 | 30.5 |

**Constant Power Discharge Data Units: Watts per cell (25°C, 77°F)**

| End voltage per cell | 15min | 20min | 30min | 40min | 50min | 1h  | 2h  | 3h  | 5h  | 8h   | 10h  |
|----------------------|-------|-------|-------|-------|-------|-----|-----|-----|-----|------|------|
| 1.65V                | 690   | 600   | 520   | 440   | 390   | 330 | 215 | 170 | 120 | 84.0 | 80.0 |
| 1.70V                | 640   | 580   | 490   | 425   | 370   | 320 | 210 | 160 | 115 | 80.5 | 75.0 |
| 1.75V                | 600   | 550   | 450   | 400   | 360   | 310 | 205 | 155 | 110 | 77.0 | 66.0 |
| 1.80V                | 530   | 480   | 420   | 360   | 315   | 305 | 200 | 145 | 105 | 73.5 | 60.0 |

**ICS series**

**ICS-300**

**Discharge Voltage vs Time Curve ( 25°C )**

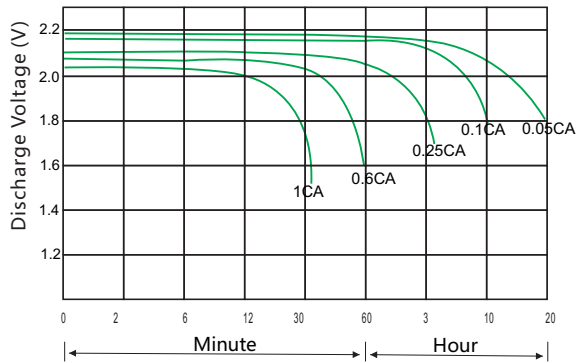

**Charge Curve (25°C)**

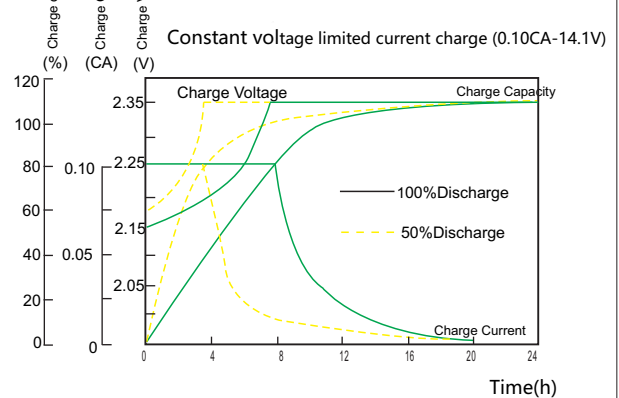

**Capacity vs temperature curve**

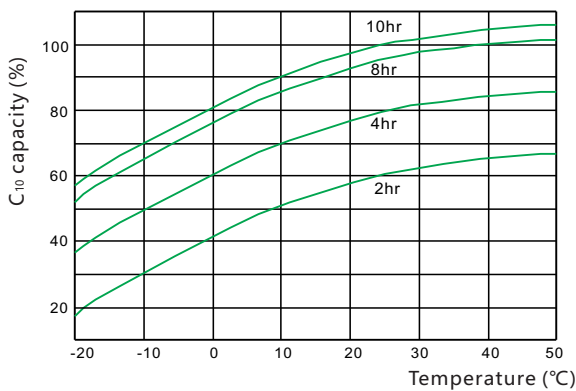

**Residual Capacity vs Storage Time**

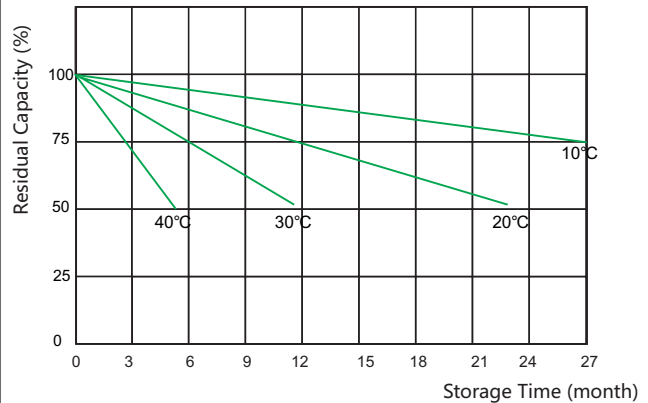

**Capacity vs OCV curve**

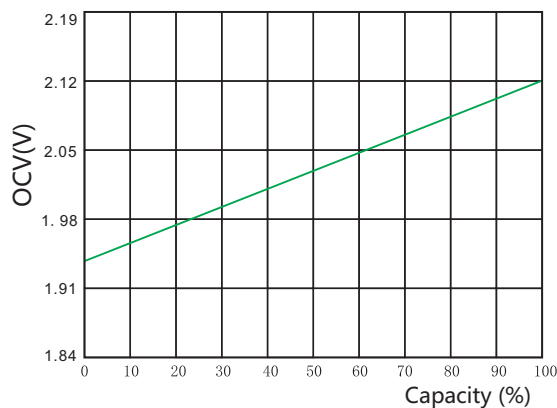

**Design life vs temperature**

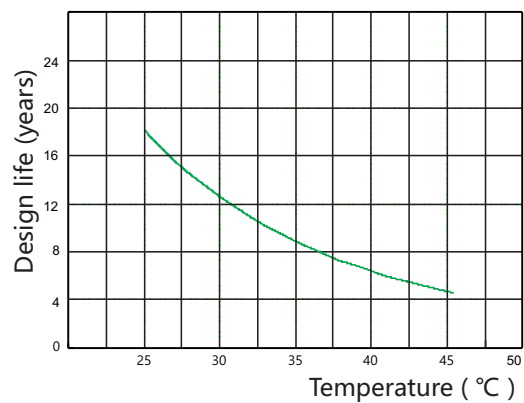

**NARADA POWER SOURCE CO.,LTD.**  
 Building A, No.822 Wen'er West Road, Hangzhou, China  
 Tel:+86-571-56975980 Fax:+86-571-56975955  
 E-mail: intl@narada.biz  
 Website:www.naradapower.com

**NARADA ASIA PACIFIC PTE.LTD.**  
 Block 9 Khaki Bukit Road 1 #02-10 Eunos Technolink,  
 Singapore 415938 Email: sales@narada-ap.com  
 Tel: +65-6848 1191 Fax: +65-6749 3498  
 Website: [www.narada-ap.com](http://www.narada-ap.com)

**NARADA EUROPE (UK) LIMITED**  
 Spectrum House, Dunstable Road, Redbourn,  
 St. Albans, Herts AL3 7PR  
 Tel: +44 (0)845 371 7095 Fax:+44 (0)845 612 2031  
 E-mail: sales@naradaeurope.com



Copyright Narada Power Source Co., Ltd.

[www.naradapower.com](http://www.naradapower.com)

**TEMPEL GROUP ARGENTINA**  
[www.tempelgroup.com](http://www.tempelgroup.com)  
 baires@tempelgroup.com  
 Tel.+54 11 4897-7184/7178

**TEMPEL GROUP en el mundo**  
 BUENO AIRES · MADRID · VALENCIA · BILBAO · SEVILLA ·  
 LISBOA · PORTO · LIMA · SÃO PAULO · SANTIAGO DE CHILE · BOGOTÁ ·  
 CIUDAD DE MÉXICO · CIUDAD DE PANAMÁ · MONTEVIDEO · QUITO

