

**ICS series**

**ICS-800**

Narada's ICS series battery designed to provide highcycling and fast charge performance, idea for telecom service where power supply is unstable. With innovative structure design, high quality manufacturing and high quality material, ICS batteries are also capable of PSoC, hybrid, renewable energy storage application and other cycling/standby applications.



**Specifications**

<b>Battery Model</b>	<b>ICS-800</b>	
Nominal voltage	2V	
Capacity	800Ah (10HR ,80A, 1.80V, 25°C)	
Approx.Weight	54.5kg	
Internal Resistance	Approx 0.21mΩ	
Max Charge Current Allowed	200A	
Charge Voltage (25°C)	Cycle use	Float use
	2.35V/cell	2.25V/cell
Temperature Ranges	Operation(maximum): -40°C to 55°C (-40°F to 131°F)	
	Operation(recommended): 15°C to 25°C ( 59°F to 77°F)	
	Storage: -20°C to 40°C (-4°F to 104°F)	
Terminal	M8 Female	
Terminal Hardware	15 ± 1.0 N.m	
Container Material	ABS (V0 optional)	

**Dimensions (mm)**

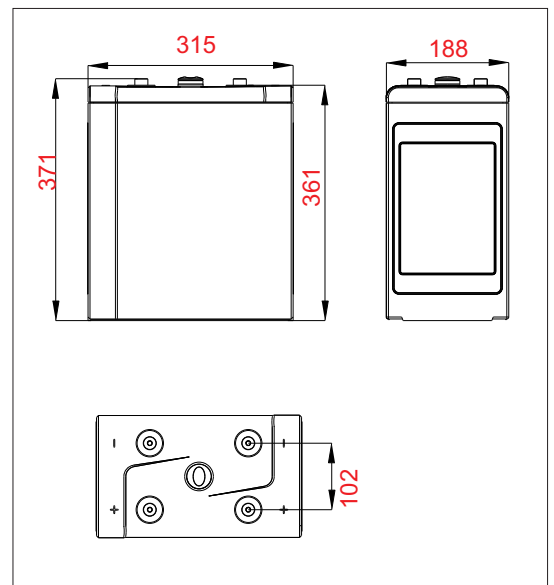

**Constant Current Discharge Data Units: Amperes (25°C, 77°F)**

End voltage per cell	15min	20min	30min	40min	50min	1h	2h	3h	5h	8h	10h
1.65V	960	920	740	640	560	450	275	208	137	95.0	84.0
1.70V	920	860	700	600	540	447	270	205	135	92.0	83.0
1.75V	850	750	650	580	520	443	267	203	133	90.0	82.0
1.80V	750	680	620	540	450	441	265	201	130	88.0	81.0

**Constant Power Discharge Data Units: Watts per cell (25°C, 77°F)**

End voltage per cell	15min	20min	30min	40min	50min	1h	2h	3h	5h	8h	10h
1.65V	1810	1620	1400	1180	1040	880	580	450	325	230	205
1.70V	1680	1540	1280	1100	990	860	550	430	315	220	195
1.75V	1600	1400	1240	1050	960	840	540	420	310	212	185
1.80V	1380	1280	1100	990	860	810	510	410	280	189	160

**ICS series**

**ICS-800**

**Discharge Voltage vs Time Curve ( 25°C )**

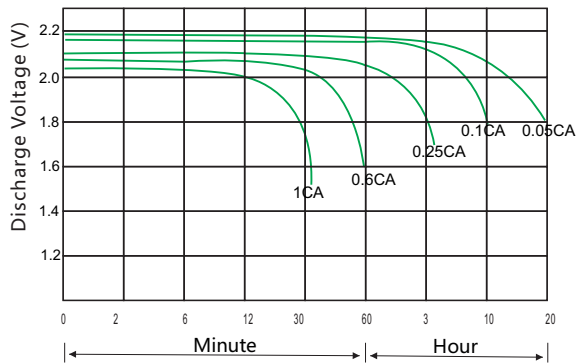

**Charge Curve (25°C)**

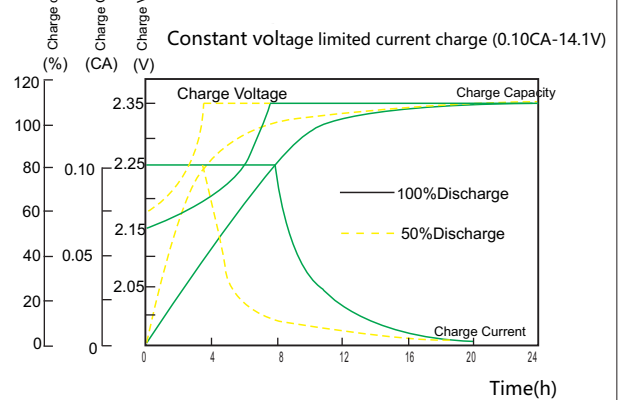

**Capacity vs temperature curve**

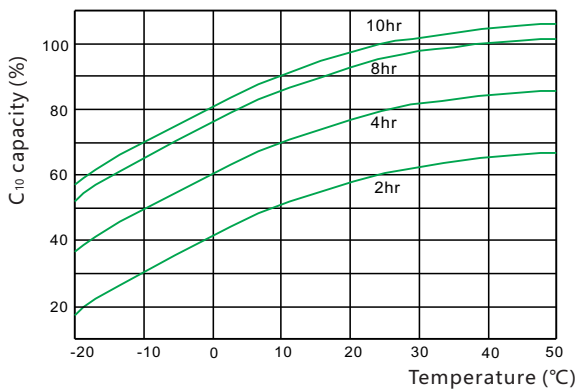

**Residual Capacity vs Storage Time**

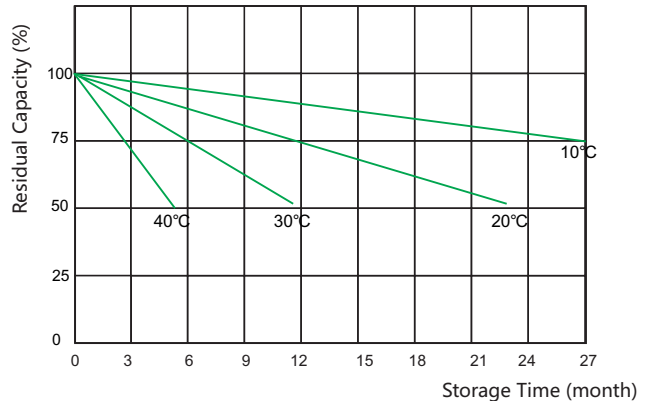

**Capacity vs OCV curve**

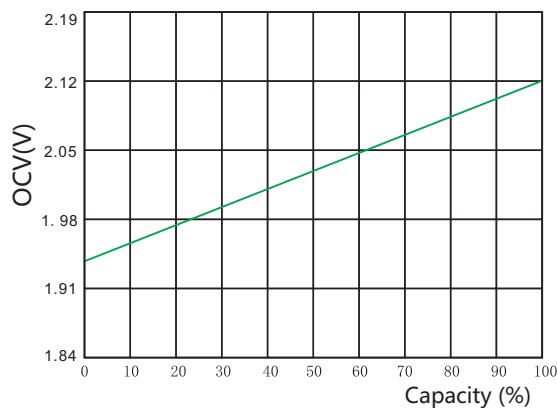

**Design life vs temperature**

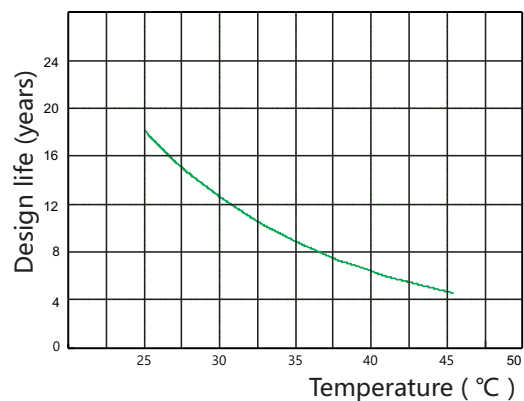

**NARADA POWER SOURCE CO.,LTD.**  
 Building A, No.822 Wen'er West Road, Hangzhou, China  
 Tel:+86-571-56975980 Fax:+86-571-56975955  
 E-mail: intl@narada.biz  
 Website:www.naradapower.com

**NARADA ASIA PACIFIC PTE.LTD.**  
 Block 9 Khaki Bukit Road 1 #02-10 Eunos Technolink,  
 Singapore 415938 Email: sales@narada-ap.com  
 Tel: +65-6848 1191 Fax: +65-6749 3498  
 Website: [www.narada-ap.com](http://www.narada-ap.com)

**NARADA EUROPE (UK) LIMITED**  
 Spectrum House, Dunstable Road, Redbourn,  
 St. Albans, Herts AL3 7PR  
 Tel: +44 (0)845 371 7095 Fax:+44 (0)845 612 2031  
 E-mail: sales@naradaeurope.com

